

LED Bay Lighting

SEGA Series (SE130)



Product Description

- Excellent heat dissipation and high efficiency
- Best fitted lighting for factories and warehouses
- Wireless control system capable of on-off and dimming control
- Wireless control system capable of daylight sensor control

Application

- Factories
- Gyms
- Warehouse
- Superstores

Certification



General Specifications	
Model Name	SE130
Size	Pipe type Ø16.5 x 21.9 (inch) / Ø420 x 556 (mm)
	Chain type Ø16.5 x 28.0 (inch) / Ø420 x 710 (mm)
Weight (Driver included)	14.3lb / 6.5kg
IP Rating	IP65
Operating Temperature	-20°C ~ 40°C
Warranty	5 Years (12 hours usage per day)
Country of Origin	GigaTera Lighting Inc. (Made in Korea)

Electrical Performance	
Input Voltage	100 ~ 277Vac / 100 ~ 240Vac / 347 ~ 480Vac
Input Current	Max. 1.55A (@100Vac)
	Max. 0.5A (@347Vac)
Power Factor	≥0.9 at Max load
Frequency	50 / 60 Hz
Surge Protection	Line – Line 4kV / Line – FG 6kV

Materials	
Body	Cast Aluminum
Optic	Al Coating Reflector
Cover	Tempered Glass 3.2T (Clear / Frosted)
Finish	Powder Coating

Option	
Control	Wireless (ZigBee)

Lumen Data (Clear)				
CCT	5700K	5000K	4000K	3000K
CRI	70 Ra			
Luminous Flux *	18,850 lm	19,500 lm	18,850 lm	17,550 lm
Luminous Efficacy *	145 lm/W	150 lm/W	145 lm/W	135 lm/W

Lumen Data (Frosted)				
CCT	5700K	5000K	4000K	3000K
CRI	70 Ra			
Luminous Flux *	17,550 lm	18,200 lm	17,550 lm	16,250 lm
Luminous Efficacy *	135 lm/W	140 lm/W	135 lm/W	125 lm/W

*Tolerance ±5%

Photometry Data – 5000K / Frosted

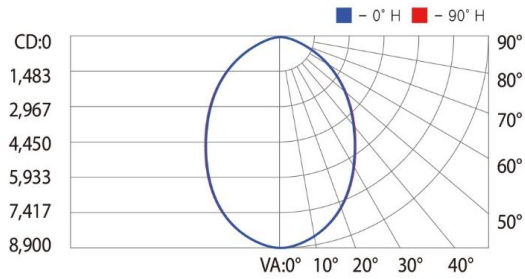

< Asymmetric Wide 90° >

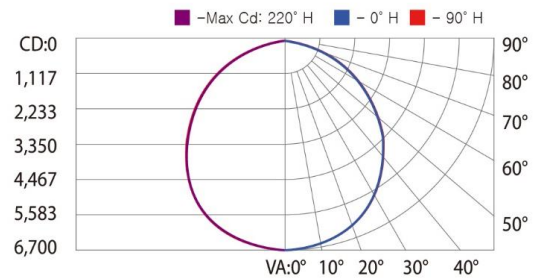

< Asymmetric Wide 130° >

Photometry Data – 5000K / Clear

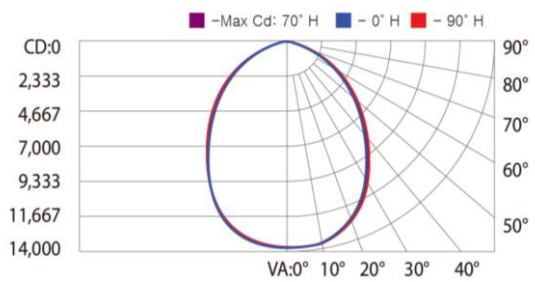

< Asymmetric Wide 90° >

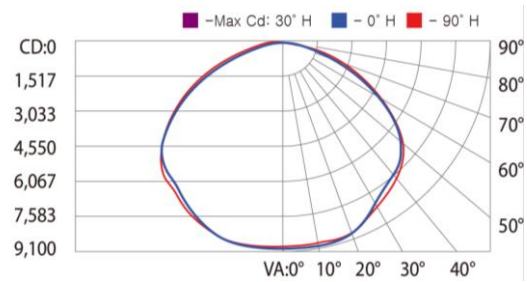

< Asymmetric Wide 130° >

Types of mounting brackets with dimension information (Optional Purchase)

Built-in type / Pipe type

- Bracket Code : KLMCL80G00380_A2

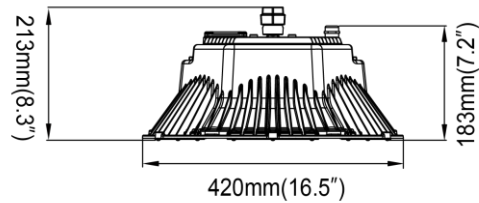
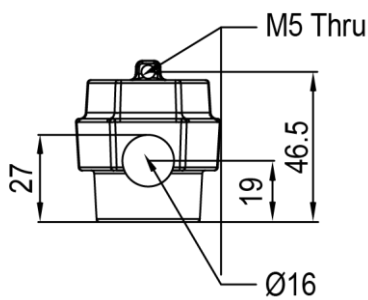

- GigaTera does not sell or supply the pip

	Size	18.9 x 28.6 (inch) / 480 x 726 (mm)
Weight	Module	14.3lb / 6.5kg
	Bracket	0.11lb / 0.05kg
	Assembly (Module + Bracket)	14.4lb / 6.55kg

Types of mounting brackets with dimension information (Optional Purchase)

Built-in type / Chain type

- Bracket Code : KLMCL80G00380_A2

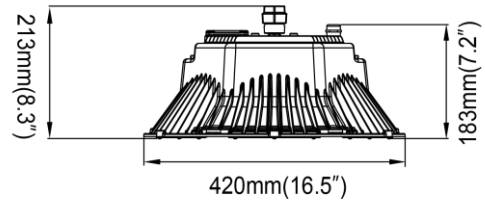
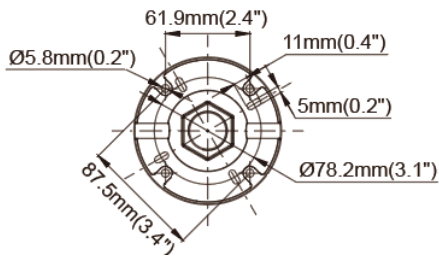

- GigaTera does not sell or supply the pip

Size		18.9 x 28.6 (inch) / 480 x 726 (mm)
Weight	Module	14.3lb / 6.5kg
	Bracket	0.33lb / 0.15kg
	Assembly (Module + Bracket)	14.6lb / 6.65kg

LED Bay Lighting

SEGA Series (SE130)

Control System (Optional)

Wireless Control	ZigBee
Input Voltage	15Vdc
Max. Power Consumption	0.3W (@15Vdc)
Standard	2.4 GHz – IEEE 802.15.4 (Compatible)
Network	Mesh
RF Tx Power	Max. +8dBm (Typ. 5dBm)
Data Rate	250 kbps
Security	128 bit AES Encryption Algorithms
Antenna	Omni Type, 2dBi
0-10V	
Factory Installed	The maximum quantity at the time of group control is according to dimmer switch and actuator supply wattage.

Ordering Information

Ordering Code Usage : SE130-A5009CNNW1							
SE	○○○	○	○○	○○○	○	○	○
	Power Consumption	Input Voltage	CCT (K)	Beam Angle (A = Asymmetric) (S = Symmetry)	Installation Type	Control System	Fixture Color
	130	A = 100 ~ 277V B = 100 ~ 240V C = 347 ~ 480V	57 = 5700K 50 = 5000K 40 = 4000K 30 = 3000K	09 = 90° 13 = 130°	CN = Chain PE = Pipe	N = None Z = ZigBee	W1 = White Ceramic